

# Design and Construction of an Automatic Solar Tracking System

Rajan Shukla, Ashish Gupta, Prince Kumar, Amar Kumar, Deep Shekhar

Department of Electronic & Communication Engineering,

IIMT College of Engineering Gr. Noida [U.P \(UPTU\)](#)

\*Email:-rshukla840@gmail.com

Under guidance:-prof.Parashuram

Email:-pp.elex06@gmail.com

**Abstract**— Energy crisis is the most important issue in today's world. Conventional energy resources are not only limited but also the prime culprit for environmental pollution. Renewable energy resources are getting priorities in the whole world to lessen the dependency on conventional resources. Solar energy is rapidly gaining the focus as an important means of expanding renewable energy uses. Solar cells those convert sun's energy into electrical energy are costly and inefficient. Different mechanisms are applied to increase the efficiency of the solar cell to reduce the cost. Solar tracking system is the most appropriate technology to enhance the efficiency of the solar cells by tracking the sun. A microcontroller based design methodology of an automatic solar tracker is presented in this paper. Light dependent resistors are used as the sensors of the solar tracker. The designed tracker has precise control mechanism which will provide three ways of controlling system. A small prototype of solar tracking system is also constructed to implement the design methodology presented here.

**Keywords**— Photovoltaic cell, solar tracking, photo resistor, microcontroller, stepper motor.

## I. INTRODUCTION

Energy is the prime factor for the development of a nation. An enormous amount of energy is extracted, distributed, converted and consumed in the global society daily. 85% of energy production is dependent on fossil fuels [1]. The resources of the fossil fuels are limited and their use results in global warming due to emission of greenhouse gases. To provide a sustainable power production and safe world to the future generation, there is a growing demand for energy from renewable sources like solar, wind, geothermal and ocean tidal wave.

The sun is the prime source of energy, directly or indirectly, which is also the fuel for most renewable systems. Among all renewable systems, photovoltaic system is the one which has a great chance to replace the conventional energy resources. Solar panel directly converts solar radiation into electrical energy. Solar panel is mainly made from semiconductor materials. Si used as the major component of solar panels, which is maximum 24.5% efficient [2]. Unless high efficient solar panels are invented, the only way to enhance the performance of a solar panel is to increase the intensity of light falling on it. Solar trackers are the most appropriate and proven technology to increase the efficiency of solar panels through keeping the panels aligned with the sun's position. Solar trackers get popularized around the world in recent days to harness solar energy in most efficient way. This is far more cost effective solution than purchasing additional solar panels [3].

In this paper the design methodology of a microcontroller based simple and easily programmed automatic solar tracker

is presented. A prototype of automatic solar tracker ensures feasibility of this design methodology.

## II. PHOTOVOLTAIC TECHNOLOGY

The most abundant and convenient source of renewable energy is solar energy, which can be harnessed by photovoltaic cells. Photovoltaic cells are the basic of the solar system. The word photovoltaic comes from "photo" means light and "voltaic" means producing electricity. Therefore, the photovoltaic process is "producing electricity directly from sunlight". The output power of a photovoltaic cell depends on the amount of light projected on the cell. Time of the day, season, panel position and orientation are also the factors behind the output power. The current-voltage and power-voltage characteristics of a photovoltaic cell are shown in Fig. 1.

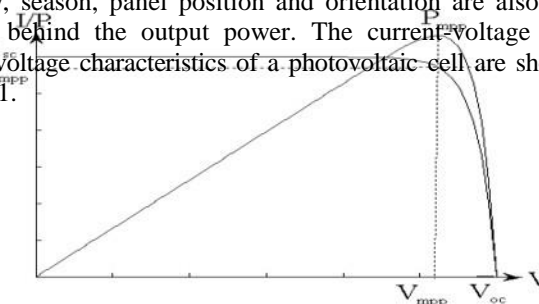

Fig. 1  $I-V$  and  $P-V$  characteristics of photovoltaic cell.

Photovoltaic cells are the smallest part of a solar panel. Solar panel gives maximum power output at the time when sun is directly aligned with the panel.

## III. TECHNOLOGY TO ENHANCE POWER OUTPUT FROM SOLAR PANEL

Increasing the cell efficiency, maximizing the power output and employing a tracking system with solar panel are three ways to increase the overall efficiency of the solar panel [4]. Improvement of solar cell efficiency is an ongoing research work and people throughout the world are actively doing research on this. Maximizing the output power from solar panel and integrating solar tracking system are the two ways where electronic design methodology can bring success.

Maximum power point tracking (MPPT) is the process to maximize the output power from solar panel by keeping the solar panel's operation on the knee point of  $P-V$  characteristics (Fig. 1). A number of MPPT algorithms have been developed and employed around the world [5]. MPPT technology only offers the maximum power that can be received from a stationary array of solar panels at a particular time; it cannot, however, increase the power generation when the sun is not aligned with the system.

Automatic solar tracker increases the efficiency of the solar panel by keeping the solar panel aligned with the rotating sun. Solar tracking is a mechanized system to track the sun's position that increases power output of solar panel 30% to 60% than the stationary system [6]. A few design methodology of solar tracking system has been proposed in recent days [7]-[9]. From these literatures it is evident that sensing of sun light, providing initial position of the solar panel and power consumption of the motor for the tracker are the major challenges of the solar tracking system.

Diffused reflection is another means to increase the efficiency of the solar panel. Maximum rays from the sun reach on the earth's surface through interaction of clouds, dusts and water. These rays are called diffused rays, which reduce the output of solar cell. If diffused rays are reflected on the panel through the reflectors it will increase the overall output of the panel [10].

IV. PROTOTYPE OF AUTOMATIC SOLAR TRACKER

Development of solar panel tracking system has been ongoing for several years. As the sun moves across the sky during the day, it is advantageous to have the solar panels track the location of the sun, such that the panels are always perpendicular with the position of the sun. Available solar trackers in the market are much costly to integrate with solar panel system [11]. In the developing countries where cost is one of the major issues to integrate technologies, solar tracking prototype presented at this paper can provide an effective solution. The major components those are used in the prototype are given below:-

- Photo resistor
- Microcontroller
- Stepper motor

A. Photo resistor

Cadmium sulphide (CdS) photo resistor is used in the designed prototype. The CdS photo resistor is a passive element that has a resistance inversely proportional to the amount of light incident on it. To utilize the photo resistor, it is placed in series with another resistor. A voltage divider is thus formed at the junction between photo resistor and another resistor; the output is taken at the junction point to pass the measured voltage as input to microcontroller. Fig. 2 represents the resistance value of the photo resistor with the illumination of light.

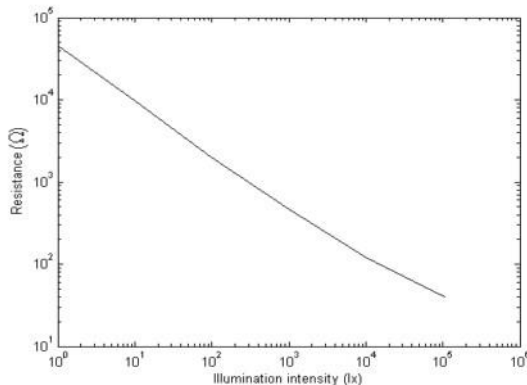

Fig. 2 Resistance value of CdS at various illumination level of light

Fig. 3 shows the schematic diagram of the prototype designed in Proteus 7 professional software.

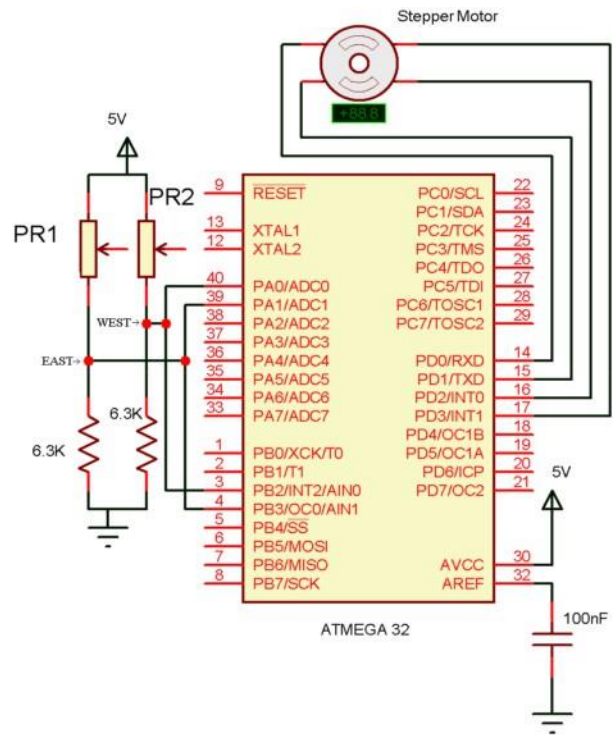

Fig. 3 Schematic of solar tracker circuitry

In the solar tracker prototype, it is desired that output voltage at junction point will increase as the light intensity increases and so the photo resistor is placed at the top position in series connection with resistor.

B. Stepper motor

Stepper motors are commonly used in precision positioning control applications. Five characteristics of the stepper motor have been considered while choosing stepper motor for the solar tracker prototype. Stepper motor is brushless, load independent, has open loop positioning capability, good holding torque and excellent response characteristics. The stepper motor that has been used in the prototype has the specifications of 24 volts, 130 Ω resistance, 7.5° per step, 4 phase, unipolar. Half stepping rotation is considered for the tracker to control position accurately with sun's rotation which results in 3.75° per step.

C. Microcontroller

The ATMEGA32 microcontroller has been used in the prototype. Microcontroller is the heart of overall system. ATMEGA32 microcontroller requires a 5 volt regulated voltage supply. '7805' voltage regulator is used to provide fixed 5 volts supply to the microcontroller [12]. ATMEGA32 has some features such as analog comparator (AC), analog to digital converter (ADC), universal synchronous asynchronous receiver transmitter (USART), times etc [13]. Utilization procedure of these features is given below:

1) Analog comparator: There are two pins which are known as analog input 0 (AIN0) and analog input 1 (AIN1). Two analog voltage signals coming from two junctions of photo resistor circuit are fed to these pins. There is a bit called analog comparator output (ACO) which is set to either '1' or '0' and can be defined as:-

$$ACO = \begin{cases} 0 & V_{AIN1} > V_{AIN0} \\ 1 & V_{AIN1} < V_{AIN0} \end{cases} \quad (1)$$

2) *Analog to digital converter*: Among 8 analog to digital converter input pins ADC0 and ADC1 have been used; where  $V_{ADC0} > V_{ADC1}$  is expected. Differential input is converted into digital value and the most 8 significant bits are defined as  $ADC\_result$  to compare with threshold.

$$ADC\_result = [V_{ADC0} - V_{ADC1}]_{digital} \quad (2)$$

This threshold value, set according to the photo resistor response against the solar radiation intensity, is provided, since  $ADC\_result$  alone might be insufficient for rotation of motor.

And if  $ADC\_result > Threshold$ ; motor rotates one step.

3) *Timers*: Built-in timer of ATMEGA32 is utilized to create delay. The Earth rotates on its own axis, with respect to the sun  $360^\circ$  in a day and so it rotates,  $(360^\circ/24=) 15^\circ$  an hour or  $3.75^\circ$  in 15 minutes. Delay for 1.5 minutes and 15 minutes are required. These delays are mentioned as *short delay* and *moderate delay* respectively.

4) *Algorithm*: In the proposed algorithm two variables  $I$  and  $Count$  have been used.  $I$  represents total number of rotation the motor must make to track the sun from dawn to dusk. First hour after the sunrise and last hour before the sunset is not considered for the tracking, as in the first hour after sunrise the west sensor does not have sufficient light than the east one; the tracker remains off (Fig. 6). The last hour before sunset will provide additional energy to rotate the panel in the initial position and so the tracker no more rotates to the west rather it will rotate reversely. As 2 hours in day time are not considered for tracking,  $(2 \times 15^\circ =) 30^\circ$  of rotation is not required to be done by the solar tracker. Half stepping of stepper motor is considered which gives  $3.75^\circ$  rotation in each stepping; approximately  $((180^\circ - 30^\circ)/3.75^\circ =) 40$  rotations are required in each day to track the sun at daylight.  $Count$  is used for counting the number of 'wait' states when weather is cloudy and ADC does not permit to rotate the motor.

A small scale prototype of the solar tracker has been made to check feasibility of the design methodology. At initial stage a small plastic board, considered as the solar panel, is mounted on an aluminium shaft. Fig. 4 illustrates the dummy panel along with other circuitry of the prototype.

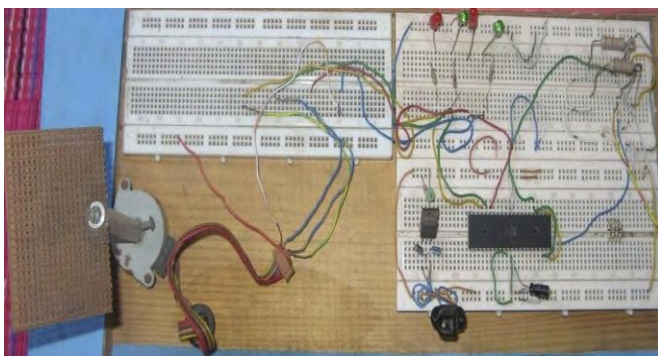

Fig. 4 Solar tracker prototype

### V. OPERATION OF THE SOLAR TRACKER

Solar tracker provides three ways of operation and control mechanism through the programme written in microcontroller. Operational flow chart of the solar tracker is given in Fig. 5.

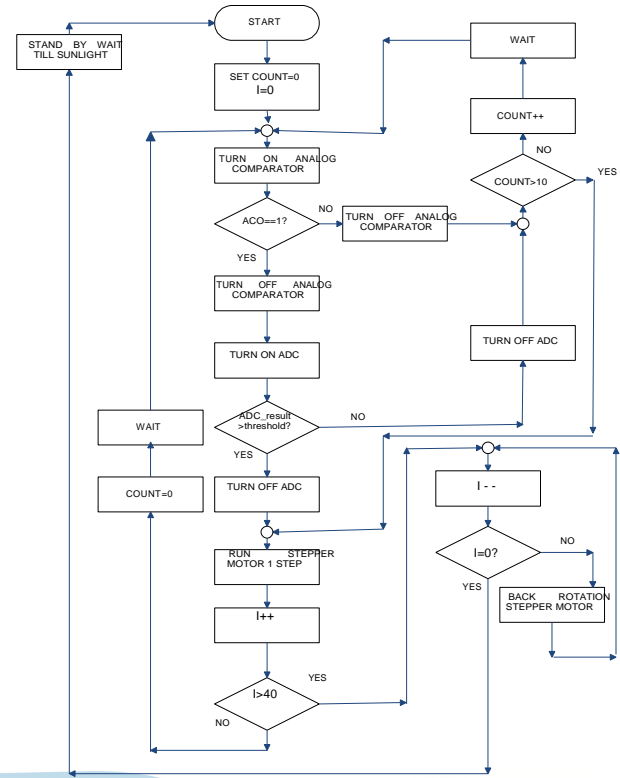

Fig. 5 Operational flow chart of the solar tracker

#### A. Normal day light condition

Two photo resistors are used in the solar tracker to compare the output voltages from two junctions. As the sun rotates from east to west in the day time, AIN0 needs to provide higher voltage than AIN1 to sense the rotation of the sun (Fig. 6). This condition is considered as normal day light condition and tracker rotates the panel  $3.75^\circ$  after every 15 minutes.

#### B. Bad weather condition

When the sky gets cloudy, there will be less striking of light on both the photo resistors and so sufficient voltages might not be available at junction point. The difference of voltage at junction point will not be greater than the threshold value to rotate the tracker. At the mean time, sun continues rotating in the western direction. To solve this problem, a *short delay* is provided which will check for voltage input from junction point in every 1.5 minutes. Microcontroller will use the variable  $Count$  to check for consecutively 10 times to make the 'wait' state equal to 15 minutes (*moderate delay*) to rotate the stepper motor one step.

#### C. Bidirectional rotation

At day time, the solar tracker will rotate in only one direction from east to west. Variable  $I$  will count the total rotation in day time and that is approximately calculated as 40 rotations considering  $150^\circ$  rotation. When the sun sets, no more rotation is needed in western direction. For the next day, the solar panel needs to go to the initial position in the morning to track the sun's position again. To do so, the variable  $I$  that counts the number of rotation in the day time will work out.

When the variable ( $I$ ) shows value greater than 40, the tracker stops rotating in the western direction and rotates reversely in the eastern direction to set the tracker to the

initial position for the next day. When it goes to initial position, power supply to the tracker will be turned off and the tracker will be in stand by till sunlight in the next morning.

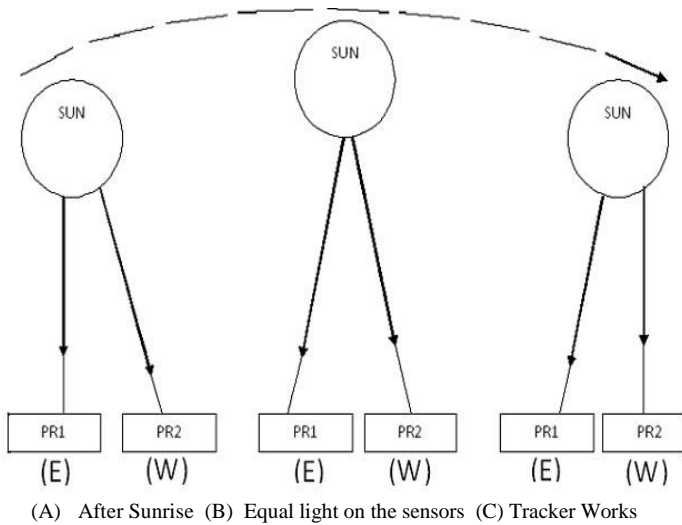

Fig. 6 Solar tracker working mechanism

VI. FEATURES & FUTURE WORK OF THE SOLAR TRACKER

While developing the overall system, hardware and software portions of the project are separated into stages consisting of light detection, microcontroller input, software enhancements, motor driving and finally dummy panel rotation.

The attractive feature of the constructed prototype is the software solution of many challenges regarding solar tracking system. The designed prototype requires only two photo resistors to sense the light, which lessens the cost of the system. Power consumption of the system is negligible as 'wait' states are calculated perfectly with the sun's position. Another major problem of system initialization at the start of the day is solved through a simple programming application. All these software based solution reduce the system cost far more than all other systems proposed to date.

As the prototype is a miniature of main system, it has some limitations which can be mitigated through future developments. In stead of solar panel, a small plastic board is rotated in the system. As a miniature system, it works out well. Solar panel must be integrated with the system to prepare result and cost analysis.

CdS photo resistors which have been used in the prototype have a better response on 500nm to 700nm of wave length [14]. As shown in Fig. 7, sunlight covers greater ranges than CdS photo resistors [15]. Hence more sensitive photo diodes should be used for wider range of sensitivity.

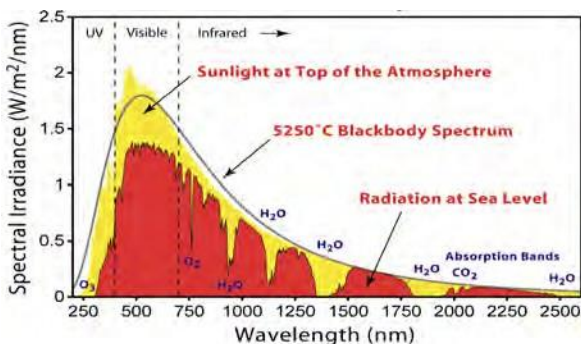

Fig. 7 Spectral irradiance of the Sun

VII. CONCLUSION

The paper has presented a means of tracking the sun's position with the help of microcontroller. Specially, it demonstrates a working software solution for maximizing solar cell output by positioning a solar panel at the point of maximum light intensity. The prototype represents a method for tracking the sun both in normal and bad weather condition. Moreover, the tracker can initialize the starting position itself which reduce the need of any more photo resistors. The attractive feature of the designed solar tracker is simple mechanism to control the system. The solar tracker also provides lucrative solution for third world countries to integrate it into their solar system with a comparatively low cost through software based solution. Though the prototype has limitations in hardware areas as an initial set up, still it provides an opportunity for improvement of the design methodology in future.

REFERENCES

- [1] International Energy Agency. [Online]. Available: [http://www.iea.org/Textbase/nppdf/free/2009/key\\_stats\\_2009.pdf](http://www.iea.org/Textbase/nppdf/free/2009/key_stats_2009.pdf)
- [2] M. A. Green, "Clean Electricity from Photovoltaics," Ed. Mary D. Archer and R. Hill, *Series on Photoconversion of Solar Energy*, V. 1, Imperial College Press, UK.
- [3] M.A. Panait and T Tudorache, "A Simple Neural Network Solar Tracker for Optimizing Conversion Efficiency in Off-Grid Solar Generator" *Intl. Conf. on Renewable Energy and Power quality*, no. 278, March, 2008.
- [4] Piao, Z.G. Park, J. M. Kim, J. H. Cho, G. B. Baek, H. L., "A study on the tracking photovoltaic system by program type," *Intl. Conf. on Electrical Machines and Systems*, vol. 2, pp. 971-973, Sept. 27-29, 2005.
- [5] C. Hua and C. Shen, "Comparative study of peak power tracking techniques for solar storage system," *Applied Power Electronics Conference and Exposition*, vol. 2, pp. 679-685, Feb. 15-19, 1998.
- [6] A. K. Saxena and V. Dutta, "A versatile microprocessor based controller for solar tracking," *Photovoltaic Specialists Conference*, vol. 2, pp. 1105-1109, 1990.
- [7] B. Koyuncu and K. Balasubramanian, "A microprocessor controlled automatic sun tracker," *IEEE Transactions on Consumer Electronics*, vol. 37, no. 4, pp. 913-917, 1991.
- [8] O. Bingol, A. Altinta, and Y. Oner, "Microcontroller based solar-tracking system and its implementation," *Journal of Engineering Sciences*, vol. 12, pp. 243-248, 2006.
- [9] M. F. Khan and R. L. Ali, "Automatic sun tracking system," *All Pakistan Engineering Conference*, Islamabad, Pakistan, 2005.
- [10] R. U. Rahman, D. I. Ahmed, M. A. Fahmi, T. Tasnuva, M. F. Khan, "Performance Enhancement of PV solar system by Diffused Reflection," *Intl. Conf. on the Developments in Renewable Energy Technology*, pp. 96-99, December, 2009.
- [11] WATTSUN™ SOLAR TRACKER RETAIL PRICE AND DATA SHEET. [Online]. Available: <http://www.wattsun.com/prices.html>
- [12] "7805" datasheet. [Online]. Available: <http://www.electrokits.com/Datasheets/7805-Datasheet>.
- [13] "Microcontroller" datasheet. [Online]. Available: [http://www.datasheetcatalog.com/datasheets\\_pdf/A/T/M/E/ATMEGA32.shtml](http://www.datasheetcatalog.com/datasheets_pdf/A/T/M/E/ATMEGA32.shtml).
- [14] "Photo sensor" datasheet. [Online]. Available: <http://www.ladyada.net/learn/sensors/cds.html>.
- [15] Nanopedia. [Online]. Available: <http://nanopedia.case.edu/image/solar.spectrum.jpg>